

F1-Series

1W Unregulated Single & Dual output

Features

- SMD 8Pin / 10Pin Package
- 4200 VDC High Isolation
- Efficiency up to 78%
- -40 ~ 105°C Operation Temperature Range
- Rated working voltage for 250Vrms and 400Vdc
- Low coupling capacity
- Qualified for Lead-free Reflow Solder Process According to IPC/JEDEC J-STD-020D.1
- Tape & Reel Package Available

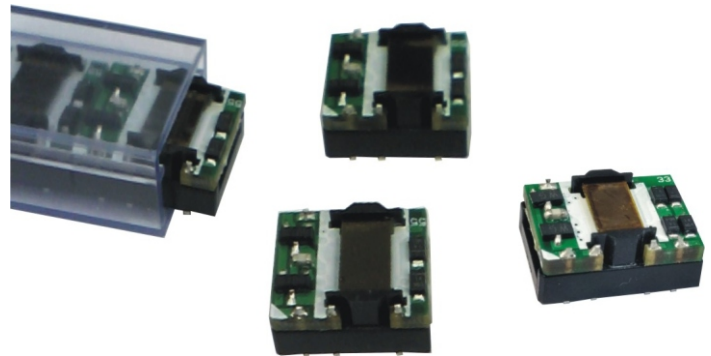

The F1 series is a family of cost effective 1W single & dual output DC-DC converters. These converters achieve low cost and Small SMD package with standard footprint. High performance features include 4200Vdc input/output isolation. Input voltages are 3.3V, 5Vdc. with output voltage of 3.3, 5, ± 3.3 , ± 5 Vdc. Standard features include an input range of $\pm 10\%$ tolerance and low output noise and ripple.

All specifications typical at Ta=25°C, nominal input voltage and full load unless otherwise specified

OUTPUT SPECIFICATIONS	
Output Voltage Accuracy	See Tolerance Envelope Curve
Line Regulation	$\pm 1.2\%$ / Per 1% Vin Change, max.
Load Regulation	(From 10% to 100% Load) 3.3 Vdc output Models $\pm 15\%$, max. 5 Vdc output Models $\pm 12\%$, max.
Ripple & Noise(1) (20 Mhz bandwidth)	Single output Models 150mVpk-pk, max. Dual output Models ± 120 mVpk-pk, max.
Short Circuit Protection	(Automatic Recovery) 0.5sec, max.
Temperature Coefficient	$\pm 0.03\%/^{\circ}\text{C}$
Capacitive Load(2)	See Table, max.

INPUT SPECIFICATIONS	
Input Voltage Range	$\pm 10\%$, max.
Input Current (Full-Load)	See Table, typ.
Input Current (No-Load)	See Table, max.
Input Filter	Capacitor
Input Reflected Ripple Current(3)	20 mA pk-pk
Start up Time (Nominal Vin and constant resistive load)	20mS, typ.

GENERAL SPECIFICATIONS	
Efficiency	See table, typ.
I/O Isolation Voltage	Qualification tested for 60sec, 4200Vdc Production tested for 3sec, 4200Vdc
I/O Isolation Capacitance	25 pF, typ.
I/O Isolation Resistance	1000M Ω , min.
Switching Frequency	50~80KHz
Humidity	95% rel H
Reliability Calculated MTBF(MIL-HDBK-217 F)	>7.0 Mhrs
Safety Standard	UL/cUL 60950-1, 62368-1 IEC/EN 60950-1, 62368-1
Safety Approvals	UL/cUL 60950-1, 62368-1 IEC/EN 60950-1, 62368-1
Moisture Sensitivity Level (MSL)	IPC/JEDEC J-STD-020D.1 Level 1

PHYSICAL SPECIFICATIONS	
Base Material	Non-conductive Black Plastic(UL94V-0 rated)
Pin Material	0.5mm C5191R-H Solder-coated
Weight	Single output Models 1.52g Dual output Models 1.80g
Dimensions	Single output Models 0.50"x0.44"x0.27" Dual output Models 0.60"x0.44"x0.27"

ENVIRONMENT SPECIFICATIONS	
Operating Temperature	-40°C ~ +105°C (See Derating Curve) -40°C ~ +100°C (For 100% load)
Storage Temperature	-55°C~125°C
Cooling(4)	Nature Convection
Lead-free Reflow Solder Process	IPC/JEDEC J-STD-020D.1
Reflow Temperature	Peak 245°C (10sec), max.
Vibration	MIL-STD-810F

ABSOLUTE MAXIMUM RATINGS(5)	
These are stress ratings. Exposure of devices to any of these conditions may adversely affect long-term reliability.	
Input Surge Voltage(1000mS)	
3.3 Models	5 Vdc, max.
5 Models	9 Vdc, max.

EMC SPECIFICATIONS		
Conducted Emissions(6)	EN55032	CLASS B
Radiated Emissions	EN55032	CLASS B
ESD	IEC 61000-4-2	Perf. Criteria A
RS	IEC 61000-4-3	Perf. Criteria A
EFT(7)	IEC 61000-4-4	Perf. Criteria A
Surge (7)	IEC 61000-4-5	Perf. Criteria A
CS	IEC 61000-4-6	Perf. Criteria A
PFMF	IEC 61000-4-8	Perf. Criteria A

The information and specifications contained in this data sheet are believed to be correct at time of publication. However, MOTIEN Technologies accepts no responsibility for consequences arising from printing errors or inaccuracies. Specifications are subject to change without notice. No rights under any patent accompany the sale of any such product(s) or information contained herein.

F1 - 1W Unregulated Single & Dual output

PART NUMBER STRUCTURE

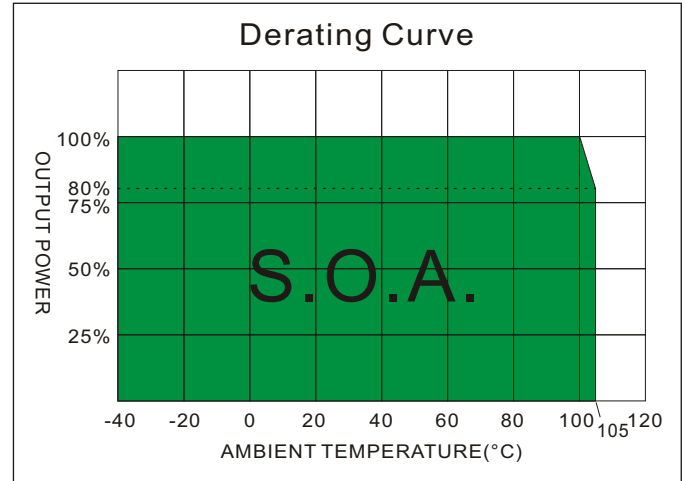
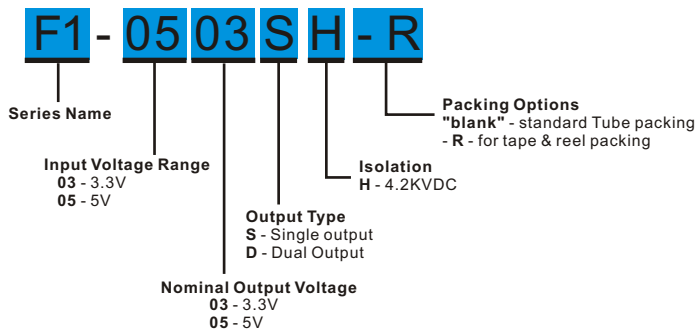

MODEL SELECTION GUIDE

MODEL NUMBER	INPUT Voltage Range (V dc)	INPUT Current		OUTPUT Voltage (V dc)	OUTPUT Current Full load (mA)	EFFICIENCY @FL (% , typ.)	Capacitor Load @FL (µF, max.)
		No-Load (mA, max.)	Full Load (mA, typ.)				
F1-0303SH	3.3 (2.97 ~ 3.63)	50	416	3.3	303	73	220
F1-0305SH	3.3 (2.97 ~ 3.63)	50	404	5	200	75	220
F1-0503SH	5 (4.5 ~ 5.5)	40	274	3.3	303	73	220
F1-0505SH	5 (4.5 ~ 5.5)	40	264	5	200	76	220
F1-0303SH-R	3.3 (2.97 ~ 3.63)	50	416	3.3	303	73	220
F1-0305SH-R	3.3 (2.97 ~ 3.63)	50	404	5	200	75	220
F1-0503SH-R	5 (4.5 ~ 5.5)	40	274	3.3	303	73	220
F1-0505SH-R	5 (4.5 ~ 5.5)	40	264	5	200	76	220
F1-0303DH	3.3 (2.97 ~ 3.63)	50	404	±3.3	±151	75	±100
F1-0305DH	3.3 (2.97 ~ 3.63)	50	389	±5	±100	78	±100
F1-0503DH	5 (4.5 ~ 5.5)	40	267	±3.3	±151	75	±100
F1-0505DH	5 (4.5 ~ 5.5)	40	257	±5	±100	78	±100
F1-0303DH-R	3.3 (2.97 ~ 3.63)	50	404	±3.3	±151	75	±100
F1-0305DH-R	3.3 (2.97 ~ 3.63)	50	389	±5	±100	78	±100
F1-0503DH-R	5 (4.5 ~ 5.5)	40	267	±3.3	±151	75	±100
F1-0505DH-R	5 (4.5 ~ 5.5)	40	257	±5	±100	78	±100

NOTE

- Ripple/Noise measured with a 10µF electrolytic capacitor and 0.1µF ceramic capacitor.
- Tested by minimal Vin and constant resistive load.
- Measured Input reflected ripple current with a simulated source inductance of 12µH And a source capacitor Cin(47µF, ESR<1.0Ω at100kHz).
- "Nature Convection" is usually about 30-65 LFM but is not equal to still air (0 LFM).
- Exceeding the absolute ratings of the unit could cause damage. It is not allowed for continuous operating.
- Input filter components are required to help meet conducted emission class B, which application refer to the EMI Filter of design & feature configuration.
- Input components (C1,D1) are used to help meet surge test requirement for the module. C1 and D1 recommended nichicon UHE series and Littelfuse SMDJ series.
- Operation under no-load conditions will not damage these devices, however they may not meet all listed specifications.
- The F1 Series of converters are not internally fused so to meet the requirements of UL an anti-surge input line fuse should always be used with ratings as defined below.
Input Voltage, 3.3V: 1.0A(Slow Burning Fuses)
Input Voltage, 5.0V: 0.5A(Slow Burning Fuses)
All fuses should be UL recognized and rated to at least the maximum allowable DC input voltage.
- It is not recommended to use water-washing process on SMT units.

The information and specifications contained in this data sheet are believed to be correct at time of publication. However, MOTIEN Technologies accepts no responsibility for consequences arising from printing errors or inaccuracies. Specifications are subject to change without notice. No rights under any patent accompany the sale of any such product(s) or information contained herein.

DERATING CURVE AND EFFICIENCY VS OUTPUT CURRENT CURVE

Single Output Tolerance Envelope Curve

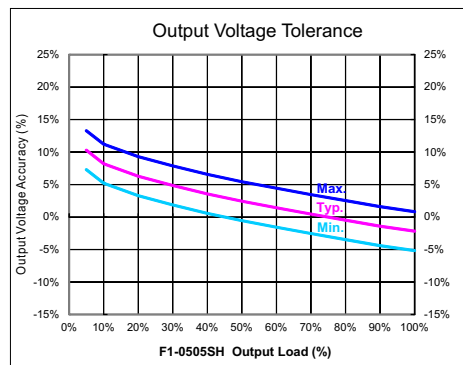
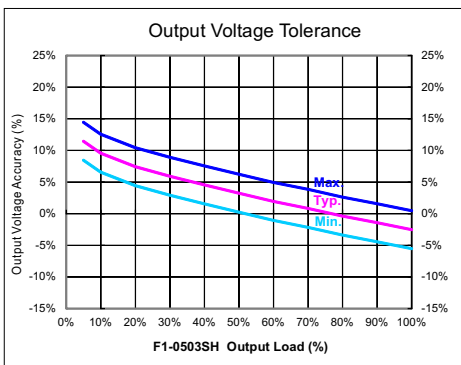
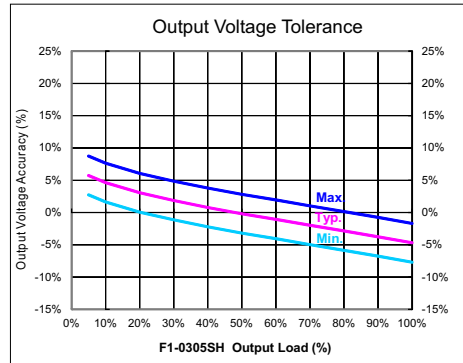
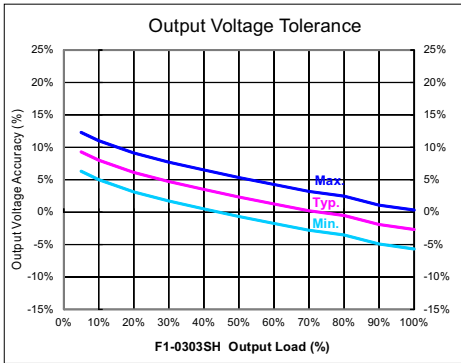

Efficiency Vs Output Current Curve

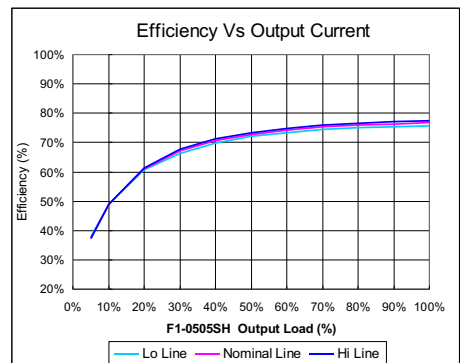
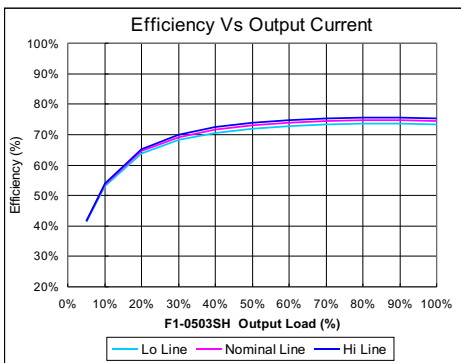
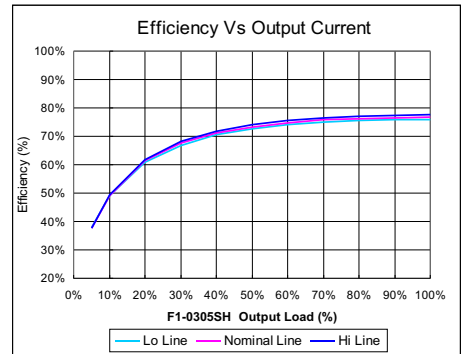
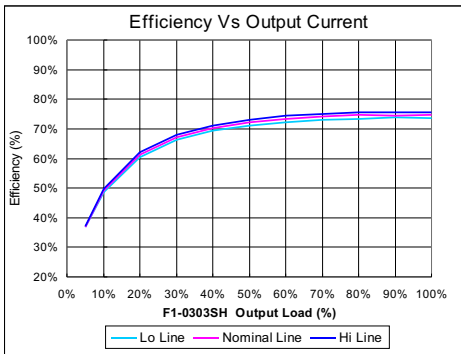

The information and specifications contained in this data sheet are believed to be correct at time of publication. However, **MOTIEN Technologies** accepts no responsibility for consequences arising from printing errors or inaccuracies. Specifications are subject to change without notice. No rights under any patent accompany the sale of any such product(s) or information contained herein.

DERATING CURVE AND EFFICIENCY Vs OUTPUT CURRENT CURVE

Dual Output Tolerance Envelope Curve

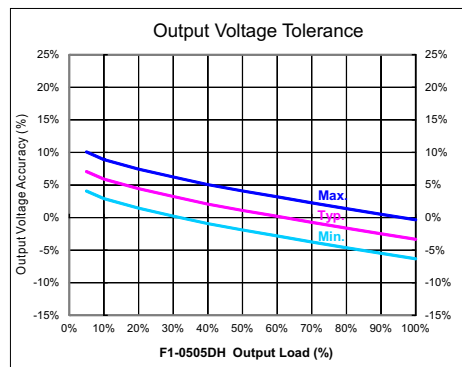
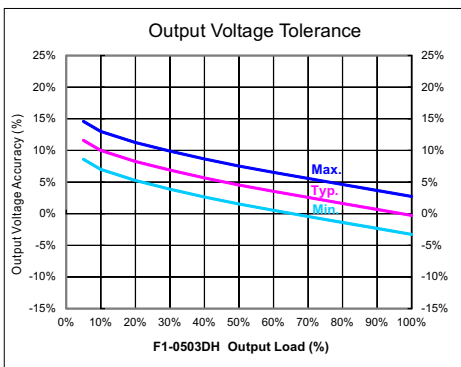
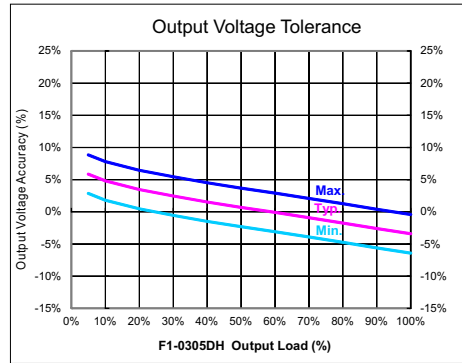
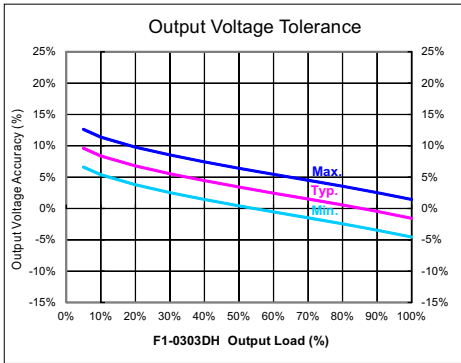

Efficiency Vs Output Current Curve

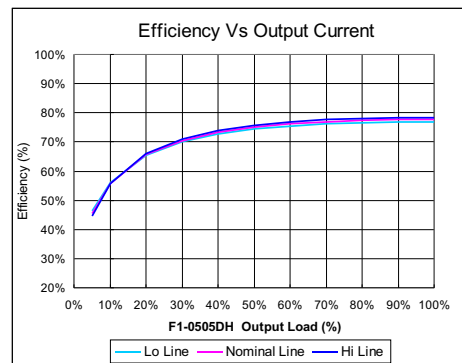
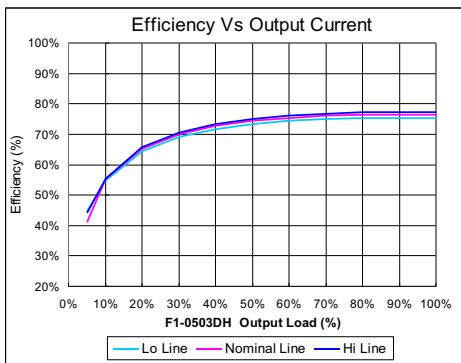
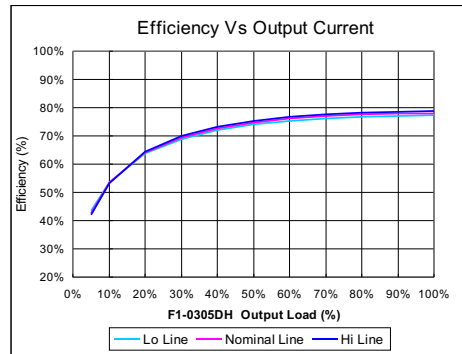
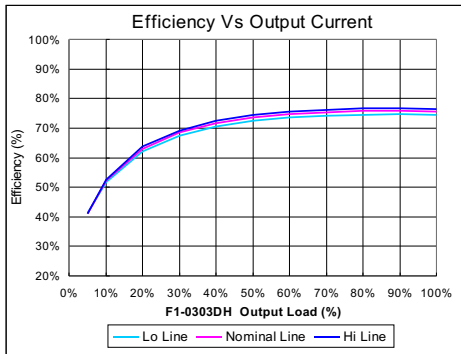

The information and specifications contained in this data sheet are believed to be correct at time of publication. However, MOTIEN Technologies accepts no responsibility for consequences arising from printing errors or inaccuracies. Specifications are subject to change without notice. No rights under any patent accompany the sale of any such product(s) or information contained herein.

TEST CONFIGURATIONS

Input Reflected Ripple Current Test Step

Input reflected ripple current is measured through a source inductor L_{in} ($12\mu H$) and a source capacitor C_{in} ($47\mu F$, $ESR < 1.0\Omega$ at $100kHz$) at nominal input and full load.

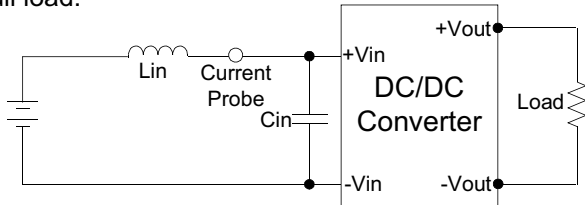

Output Ripple & Noise Measurement Test

Use a $10\mu F$ electrolytic capacitor and $0.1\mu F$ ceramic capacitor.

The Scope measurement bandwidth is 0-20MHz.

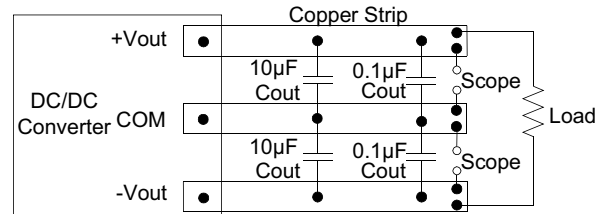

EFT & SURGE Filter

Input components ($C1, D1$) are used to help meet surge test requirement for the module.

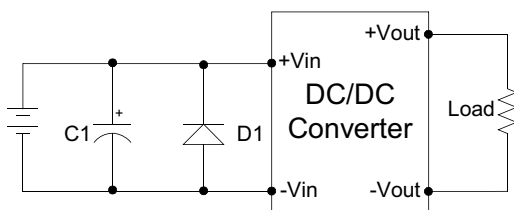

C1	D1
330µF/50V	SMDJ9.0A

D1: Transient Voltage Suppression Diodes

EMI Filter

Input filter components ($C1, L$) are used to help meet conducted emissions requirement for the module. These components should be mounted as close as possible to the module; and all leads should be minimized to decrease radiated noise.

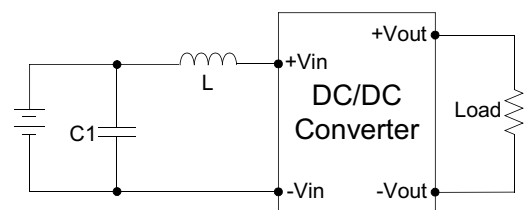

C1	L
1206, 22µF/10V	6.8µH

MECHANICAL SPECIFICATIONS - Single Output Models

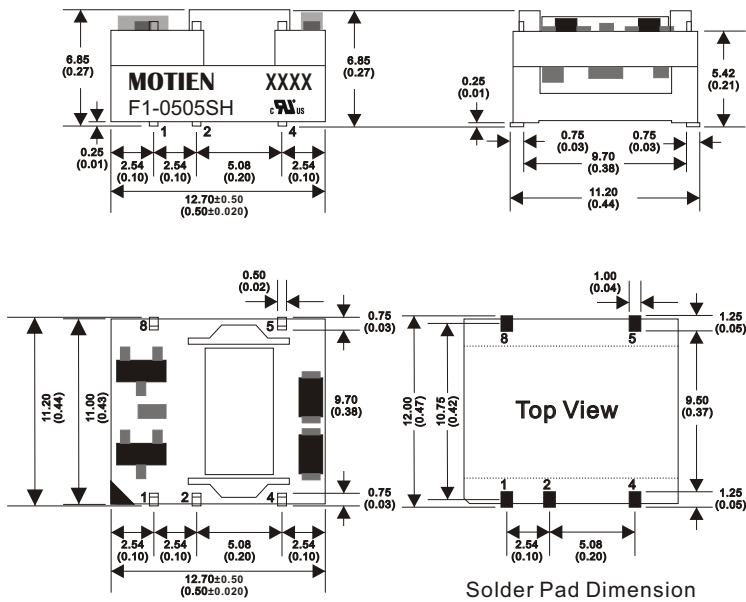

PIN CONNECTIONS	
PIN NUMBER	SINGLE
1	- V Input
2	+V Input
4	- V Output
5	+V Output
8	N.C

SMD 8Pin Package

Notes : All dimensions are typical in millimeters (inches).
 1. Not marked Tolerances: ±0.25 (±0.01)
 2. N.C = No Connection

MECHANICAL SPECIFICATIONS - Dual Output Models

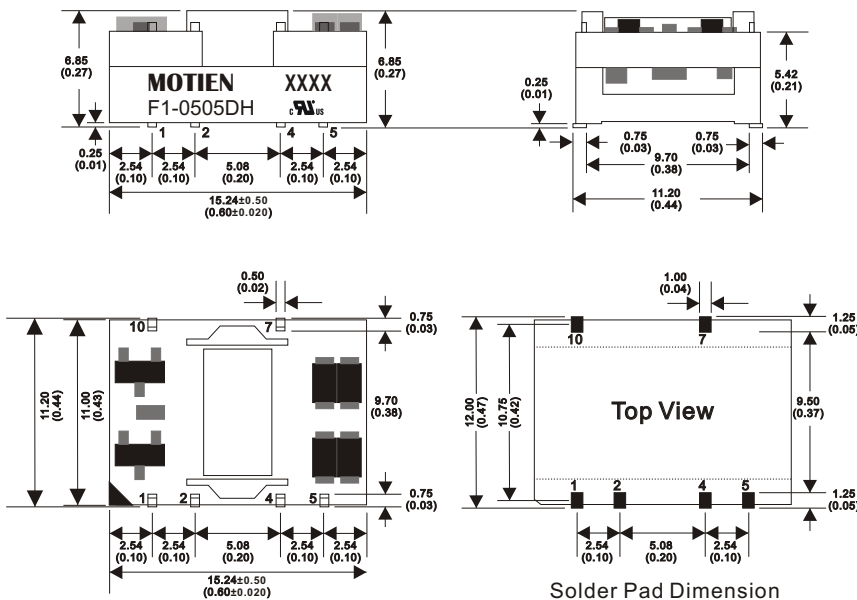

PIN CONNECTIONS	
PIN NUMBER	DUAL
1	- V Input
2	+V Input
4	Common
5	- V Output
7	+V Output
10	N.C

SMD 10Pin Package

Notes : All dimensions are typical in millimeters (inches).
 1. Not marked Tolerances: ±0.25 (±0.01)
 2. N.C = No Connection

F1 - 1W Unregulated Single & Dual output

Tube dimension - Single Output Models

Standard packing - Tube

■ 1 Tube contains 40 converters

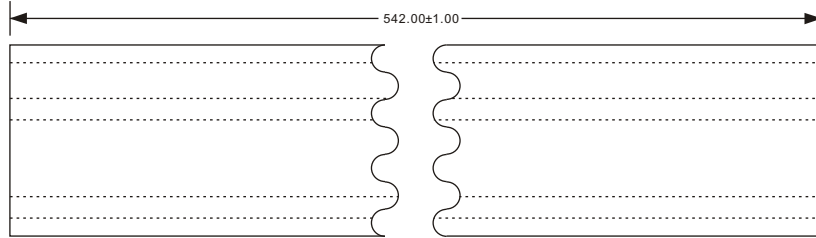

dimensions in [mm]

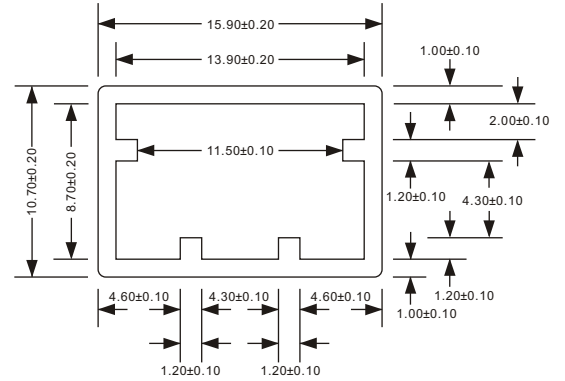

Tube dimension - Dual Output Models

Standard packing - Tube

■ 1 Tube contains 30 converters

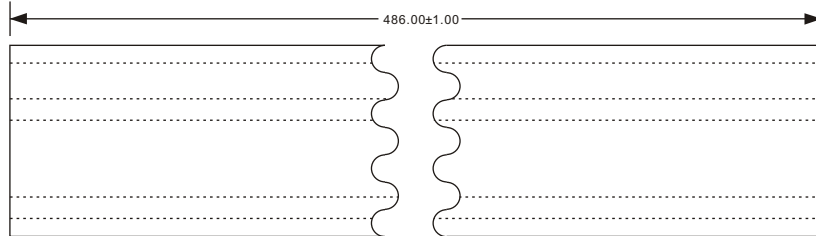

dimensions in [mm]

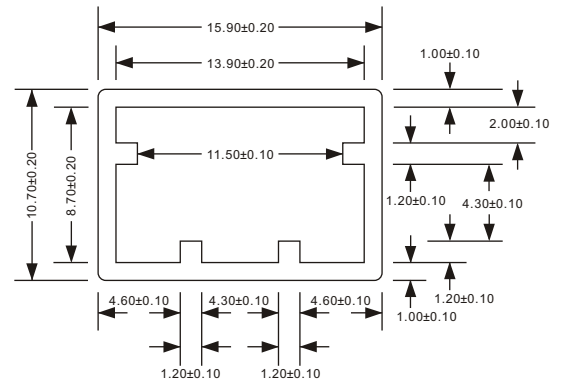

Tape & Reel dimension - Single Output Models

Optional packing - Tape & Reel

- Specifications shall conform with current EIA-481 standard
- 1 Reel contains 500 converters
- Use appendix <<-R>> on order code

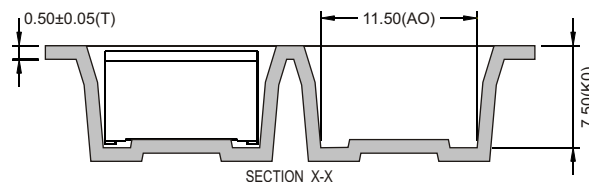
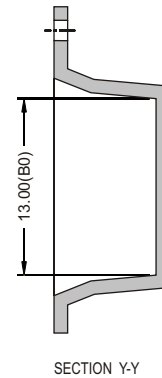
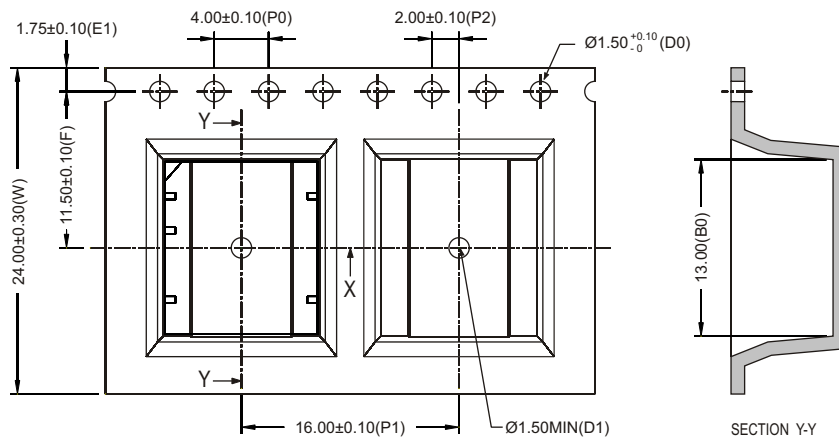
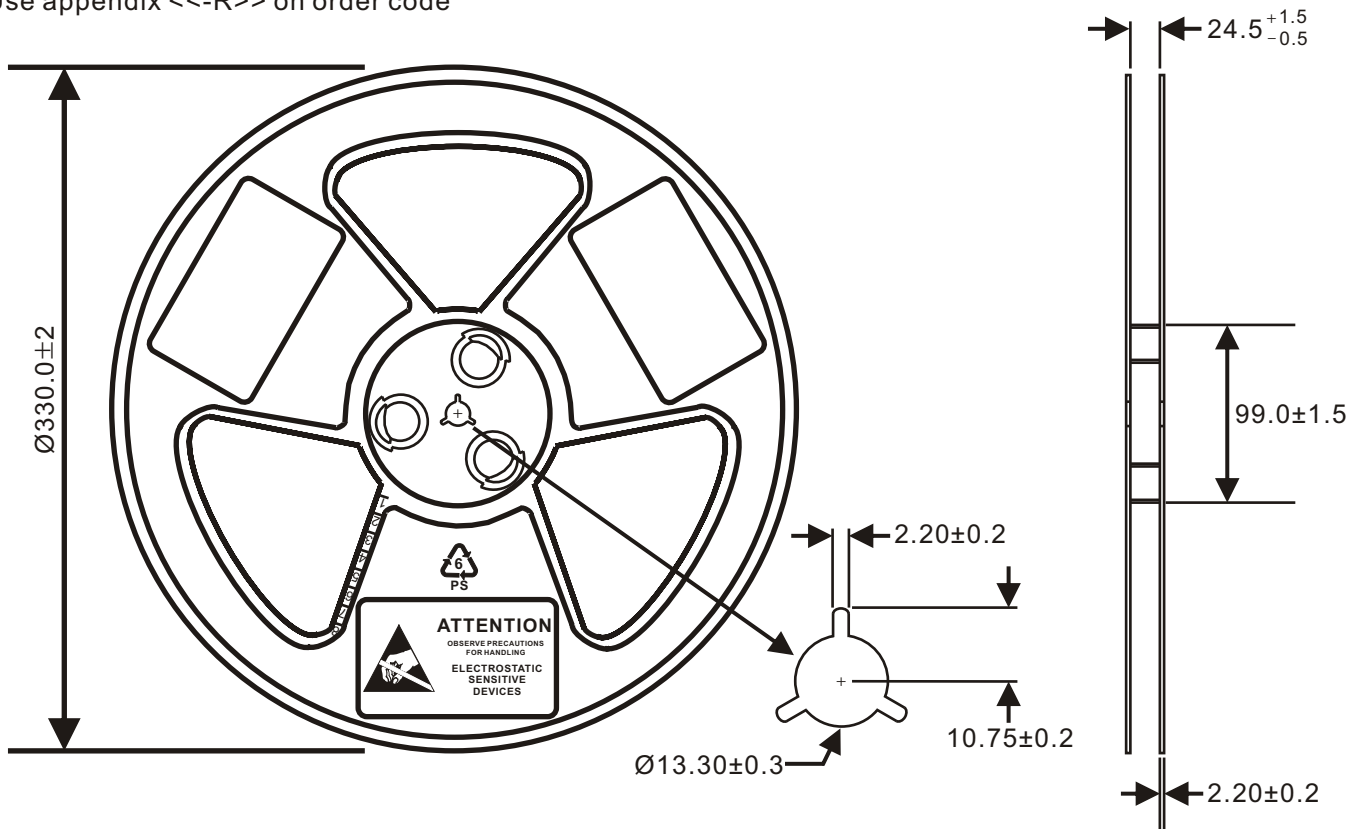

dimensions in [mm]

NOTE:

1. Material: Black Polystyrene.
2. Camber not to exceed 1mm in 100mm.
3. 10 sprocket hole pitch cumulative tolerance ±0.2
4. A0 and B0 measured on a plane 0.3mm above the bottom of the pocket.
5. K0 measured from a plane on the inside bottom of the pocket to the top surface of the carrier.
6. Pocket position relative to sprocket hole measured as true position of pocket, not pocket hole.

Carrier Length: 26M / 22" reel, Q'ty= 500 pcs/13"reel												
ITEM	W	A0	B0	K0	P1	F	E1	D0	P0	P2	T	D1
DIM	24.0 ^{+0.30} / _{-0.30}	11.5 ^{+0.10} / _{-0.10}	13.0 ^{+0.10} / _{-0.10}	7.50 ^{+0.15} / _{-0.15}	16.0 ^{+0.10} / _{-0.10}	11.50 ^{+0.10} / _{-0.10}	1.75 ^{+0.10} / _{-0.10}	1.50 ^{+0.10} / _{-0.00}	4.00 ^{+0.10} / _{-0.10}	2.00 ^{+0.10} / _{-0.10}	0.50 ^{+0.05} / _{-0.05}	1.50 MIN

The information and specifications contained in this data sheet are believed to be correct at time of publication. However, **MOTIEN Technologies** accepts no responsibility for consequences arising from printing errors or inaccuracies. Specifications are subject to change without notice. No rights under any patent accompany the sale of any such product(s) or information contained herein.

Tape & Reel dimension - Dual Output Models

Optional packing - Tape & Reel

- Specifications shall conform with current EIA-481 standard
- 1 Reel contains 450 converters
- Use appendix <<-R>> on order code

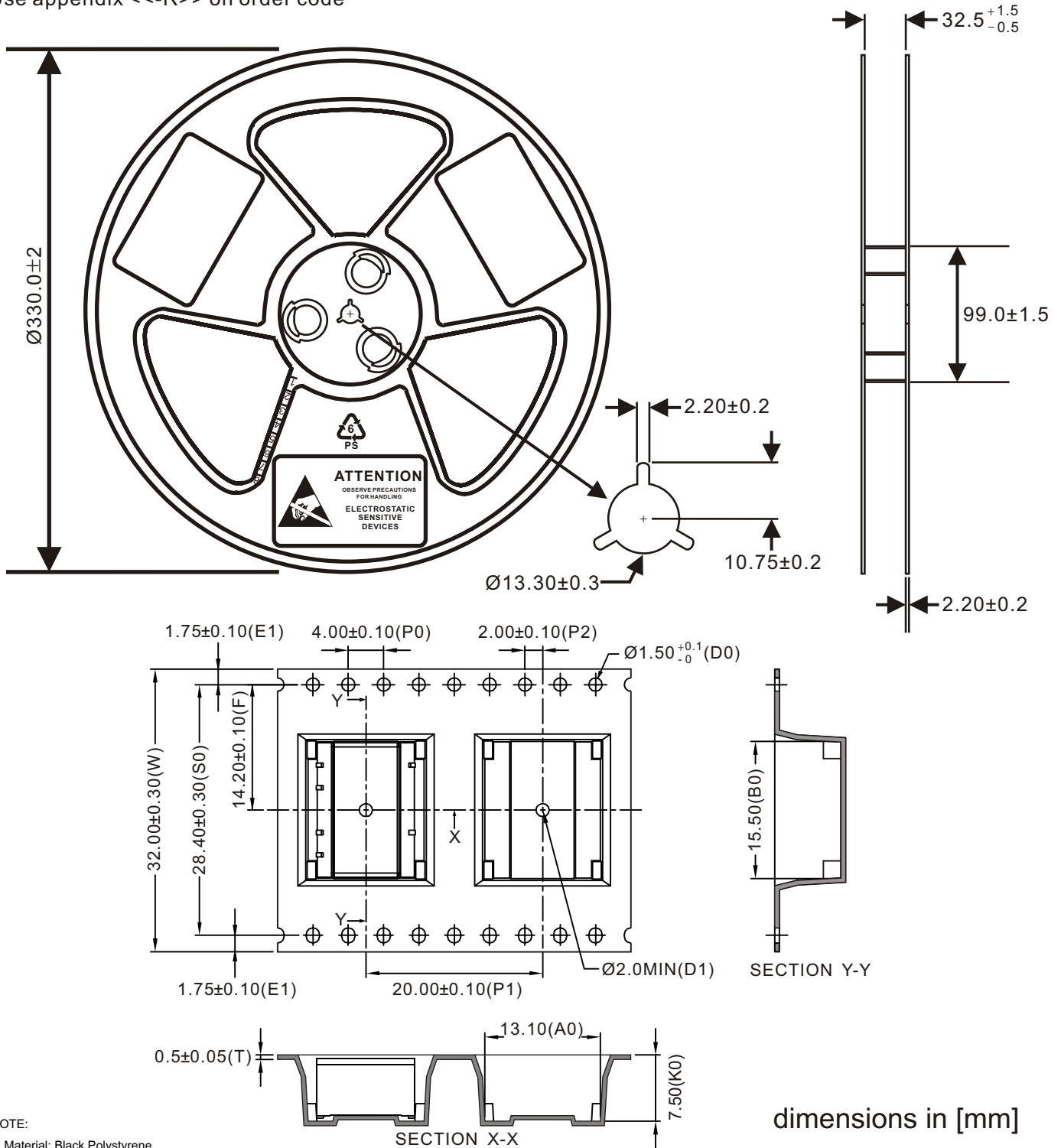

dimensions in [mm]

NOTE:

1. Material: Black Polystyrene.
2. Camber not to exceed 1mm in 100mm.
3. 10 sprocket hole pitch cumulative tolerance ± 0.2
4. A0 and B0 measured on a plane 0.3mm above the bottom of the pocket.
5. K0 measured from a plane on the inside bottom of the pocket to the top surface of the carrier.
6. Pocket position relative to sprocket hole measured as true position of pocket, not pocket hole.

Carrier Length: 30M / 22" reel, Q'ty= 450 pcs/13"reel													
ITEM	W	S0	F	E1	P0	P1	P2	D0	A0	B0	K0	T	D1
DIM	32.00 ^{+0.30} _{-0.30}	28.40 ^{+0.30} _{-0.30}	14.20 ^{+0.10} _{-0.10}	1.75 ^{+0.10} _{-0.10}	4.00 ^{+0.10} _{-0.10}	20.00 ^{+0.10} _{-0.10}	2.00 ^{+0.10} _{-0.10}	1.50 ^{+0.10} _{-0.00}	13.10 ^{+0.20} _{-0.20}	15.50 ^{+0.20} _{-0.20}	7.50 ^{+0.20} _{-0.20}	0.50 ^{+0.05} _{-0.05}	2.00MIN

The information and specifications contained in this data sheet are believed to be correct at time of publication. However, MOTIEN Technologies accepts no responsibility for consequences arising from printing errors or inaccuracies. Specifications are subject to change without notice. No rights under any patent accompany the sale of any such product(s) or information contained herein.