

MBW-3W Series



3W 4:1 Regulated Single & Dual output

Features

- Highest Power Density In 6 Pin SIL Package
- Wide 4:1 Input Range
- Smallest Footprint 3W Converter
- Full SMD Technology
- 1600 VDC Isolation
- Continuous Short Circuit Protection
- Under Voltage Lock-Out Circuit
- Efficiency up to 84%
- -40 ~ 76°C Operation Temperature Range



The MBW-3W series is a family of cost effective and high performed 3W single & dual output DC-DC converters. These converters are built in non-conductive black plastic package in a 6-pin SIL miniature compact case with high performance features wide range devices operate over 4:1 input voltage range providing stable output voltage. Devices are encapsulated using flame retardant resin. Input voltages of 12, 24, 48 Vdc with output voltage of 3.3, 5, 12, 15, ± 5 , ± 12 , ± 15 Vdc. High performance features include high efficiency operation up to 84% and output voltage accuracy of $\pm 1\%$ maximum.

All specifications typical at $T_a=25^\circ\text{C}$, nominal input voltage and full load unless otherwise specified

OUTPUT SPECIFICATIONS		PHYSICAL SPECIFICATIONS	
Voltage Accuracy	$\pm 1\%$, max.	Case Material	Non conductive black plastic (UL94V-0 rated)
Maximum Output Current	See table	Potting Material	Epoxy (UL94V-0 rated)
Line Regulation	$\pm 0.2\%$, max.	Pin Material	C5191R-H Solder-coated
Load Regulation (From 0% to 100% Load)	$\pm 1.0\%$, max.	Weight	3.85g, typ.
Cross Regulation (Dual Output) (1)	$\pm 5\%$, max.	Dimensions	0.69"x0.40"x0.48"
Ripple & Noise (20 MHz bandwidth)(2)	Single 150mVpp, max. Dual 100mVpp, max.	ENVIRONMENT SPECIFICATIONS	
Short Circuit Protection	Indefinite (Automatic Recovery)	Operating Temperature	-40°C~76°C (See Derating Curve) -40°C~71°C (For 100% Load)
Temperature Coefficient	$\pm 0.02\%/^\circ\text{C}$	Maximum Case Temperature	100°C
Capacitive Load(3)	See table	Storage Temperature	-55°C~125°C
Transient Recovery Time (4)	500us, typ.	Cooling(6)	Nature Convection
Transient Response Deviation(4)	$\pm 3\%$, max. Single Output 3.3V, 5V: $\pm 5\%$, max.	ABSOLUTE MAXIMUM RATINGS(7)	
INPUT SPECIFICATIONS		These are stress ratings. Exposure of devices to any of these conditions may adversely affect long-term reliability.	
Voltage Range	See table	Input Surge Voltage(100ms max)	
Start up Time(Nominal V_{in} and constant resistive load)	30mS, typ.	12 Models	25Vdc, max.
Input Current	See table	24 Models	50Vdc, max.
No-Load Input Current	See table	48 Models	100Vdc, max.
Input Filter	Capacitor	Soldering Temperature	260°C, max.
Input Reflected Ripple Current(5)	20mA pk-pk, typ.	(1.5mm from case 10 sec. max.)	
Remote on/off		EMC CHARACTERISTICS	
ON:	open or high impedance	Radiated Emissions(8)	EN55032 CLASS A
OFF:	2-4mA input current (via 1K)	Conducted Emissions(8)	EN55032 CLASS A
Off stand by input current(Nominal V_{in})	2.5mA, max.	ESD	IEC61000-4-2 Perf. Criteria A
Under Voltage Lockout		RS	IEC61000-4-3 Perf. Criteria A
12V Modes	Module ON / OFF	EFT(9)	IEC61000-4-4 Perf. Criteria A
24V Modes	Module ON / OFF	Surge(9)	IEC61000-4-5 Perf. Criteria A
48V Modes	Module ON / OFF	CS	IEC61000-4-6 Perf. Criteria A
		PFMF	IEC61000-4-8 Perf. Criteria A
GENERAL SPECIFICATIONS			
Efficiency	See table, typ.		
I/O Isolation Voltage (tested for 60 sec)	1600Vdc		
I/O Isolation Capacity	40 pF, max.		
I/O Isolation Resistance	1000M Ohm, min.		
Switching Frequency	100kHz, min.		
Humidity	95%reIH		
Reliability Calculated MTBF (MIL-HDBK-217 F)	>956Khrs@25°C		
Safety Standard	IEC/EN 60950-1, 62368-1 UL/cUL 62368-1		
Safety Approvals	IEC/EN 60950-1, 62368-1 UL/cUL 62368-1		

The information and specifications contained in this data sheet are believed to be correct at time of publication. However, MOTIEN Technologies accepts no responsibility for consequences arising from printing errors or inaccuracies. Specifications are subject to change without notice. No rights under any patent accompany the sale of any such product(s) or information contained herein.

PART NUMBER STRUCTURE

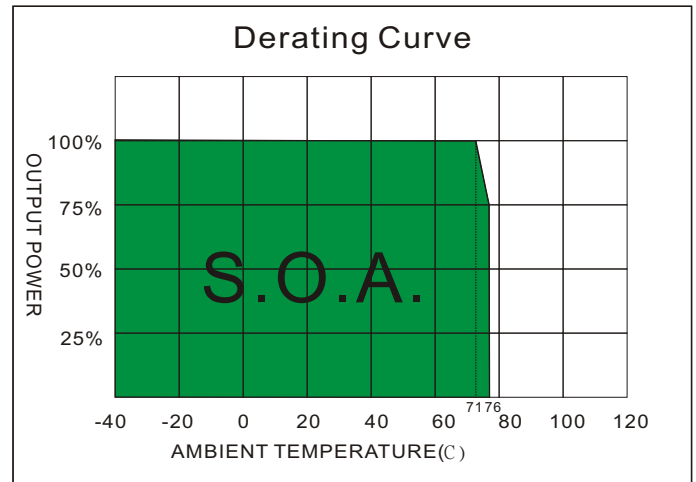
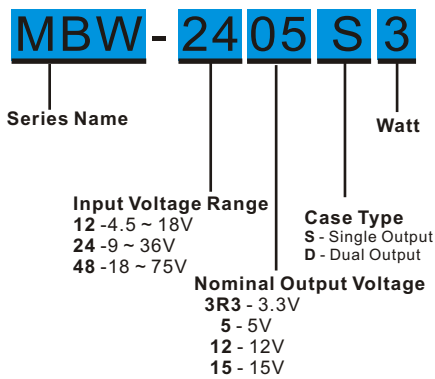

MODEL SELECTION GUIDE

MODEL NUMBER	INPUT Voltage Range (Vdc)	INPUT Current		OUTPUT Voltage (Vdc)	OUTPUT Current		EFFICIENCY @FL (%.typ)	Capacitor Load @FL (uF,max)
		No-Load (mA,max)	Full Load (mA,typ.)		Min. load (mA)	Full load (mA)		
MBW-123R3S3	12 (4.5-18)	45	257	3.3	0	700	75	3300
MBW-1205S3	12 (4.5-18)	45	309	5	0	600	81	1680
MBW-1212S3	12 (4.5-18)	50	301	12	0	250	83	820
MBW-1215S3	12 (4.5-18)	55	301	15	0	200	83	680
MBW-1205D3	12 (4.5-18)	40	313	±5	0	±300	80	±1000
MBW-1212D3	12 (4.5-18)	50	305	±12	0	±125	82	±470
MBW-1215D3	12 (4.5-18)	60	301	±15	0	±100	83	±330
MBW-243R3S3	24 (9-36)	25	127	3.3	0	700	76	3300
MBW-2405S3	24 (9-36)	25	152	5	0	600	82	1680
MBW-2412S3	24 (9-36)	35	149	12	0	250	84	820
MBW-2415S3	24 (9-36)	35	149	15	0	200	84	680
MBW-2405D3	24 (9-36)	30	154	±5	0	±300	81	±1000
MBW-2412D3	24 (9-36)	35	151	±12	0	±125	83	±470
MBW-2415D3	24 (9-36)	40	149	±15	0	±100	84	±330
MBW-483R3S3	48 (18-75)	15	65	3.3	0	700	74	3300
MBW-4805S3	48 (18-75)	15	77	5	0	600	81	1680
MBW-4812S3	48 (18-75)	15	77	12	0	250	81	820
MBW-4815S3	48 (18-75)	20	76	15	0	200	82	680
MBW-4805D3	48 (18-75)	15	79	±5	0	±300	79	±1000
MBW-4812D3	48 (18-75)	20	78	±12	0	±125	80	±470
MBW-4815D3	48 (18-75)	30	78	±15	0	±100	80	±330

NOTE

- One load is 25% to 100% load, the other load is 100% load, the output voltage variable rate is within ±5%.
- Ripple/Noise measured with a 10µF electrolytic capacitor and 0.1µF ceramic capacitor.
- Test by minimal Vin and constant resistive load.
- Test by normal Vin and 100%-25% load, 25% load step change.
- Measured Input reflected ripple current with a simulated source inductance of 27µH and a source capacitor Cin(47µF, ESR<1.0Ω at 100KHz).
- "Nature Convection" is usually about 30-65 LFM but is not equal to still air (0 LFM).
- Exceeding the absolute ratings of the unit could cause damage. It's not allowed for continuous operating ratings.
- Input filter components are required to help meet conducted emission and radiated emission class A, which application refer to the EMI filter of design & feature configuration.
- An external filter capacitor is required if the module has to meet IEC61000-4-4 and IEC61000-4-5. The filter capacitor Motien suggest: Nippon - chemi - con KY series, 220µF/100V.

The models listed above is just for standard type. If you need the special specification product, please contact our service member by telephone presented in shortform cover or e-mail to : sales@motien.com.tw

TEST CONFIGURATIONS

Output Ripple & Noise Measurement Test

Use a 10 μ F electrolytic capacitor and 0.1 μ F ceramic capacitor.
The Scope measurement bandwidth is 20MHz.

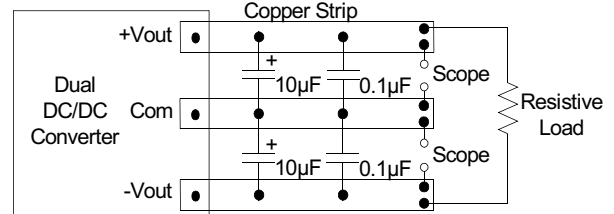
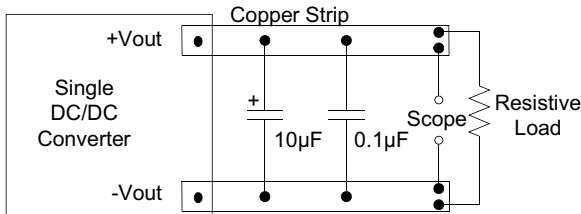

Input Reflected Ripple Current Test Step

Input reflected ripple current is measured through a source inductor L_{in} (27 μ H) and a source capacitor C_{in} (47 μ F, ESR<1.0 Ω at 100KHz) at nominal input and full load.

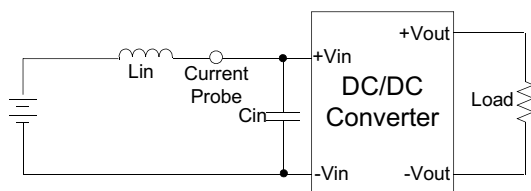

EFT/Surge Filter

Input filter components (C2) is used to help meet IEC61000-4-4 and IEC61000-4-5 .

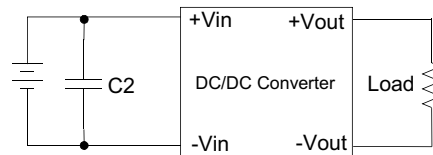

C2	
MBW-XXXXX3	220 μ F, 100V

EMI Filter(Conducted Emissions)

Input filter components (C1,Cy,L1) are used to meet EMI test criterial A.
These components should be mounted as close as possible to the module; and all leads should be minimized to decrease radiated noise.

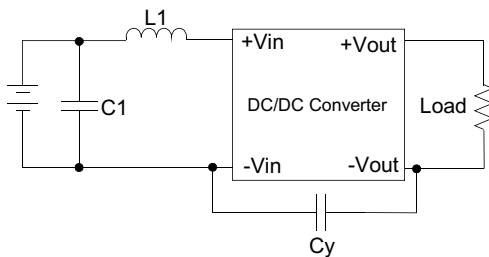

	C1	L1	Cy
MBW-12XXX3	1210,10 μ F,35V	2.2 μ H	1206,100pF,2kV
MBW-24XXX3	1210,2.2 μ F,100V	10 μ H	1206,100pF,2kV
MBW-48XXX3	1210,4.7 μ F,100V	18 μ H	1206,100pF,2kV

EMI Filter(Radiated Emissions)

Input filter components (Cy) is used to meet EMI test criterial A.
These components should be mounted as close as possible to the module; and all leads should be minimized to decrease radiated noise.

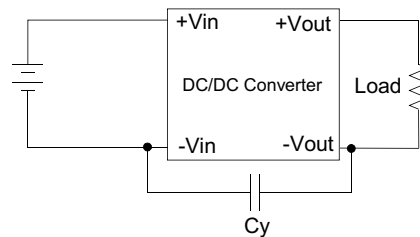

Cy	
MBW-XXXXX3	1206,100pF,2kV

TEST CONFIGURATIONS

Remote ON / OFF Test Step

Input current(2~4mA) via 1KΩ to Pin3 , converter OFF.
open or high impedance , converter ON.

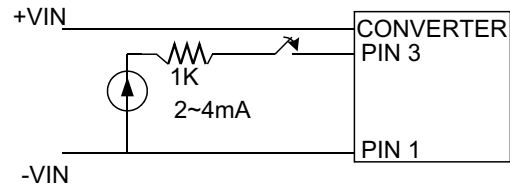

MECHANICAL SPECIFICATION

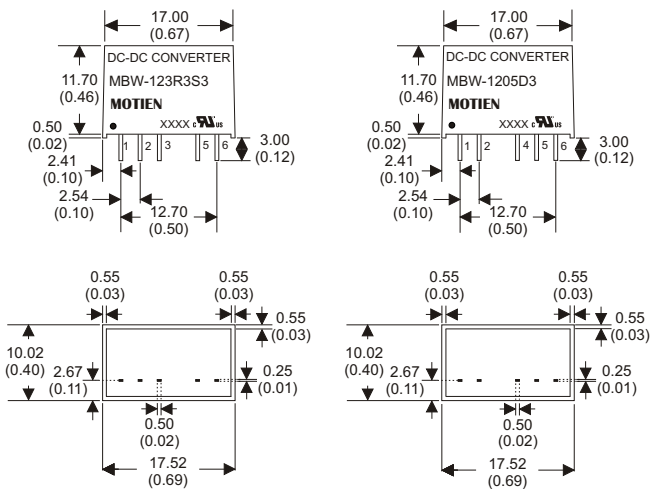

PIN CONNECTIONS		
PIN NUMBER	SINGLE	DUAL
1	-V Input	-V Input
2	+V Input	+V Input
3	Remote On/Off	N.P.
4	N.P.	+V Output
5	+V Output	Common
6	-V Output	-V Output

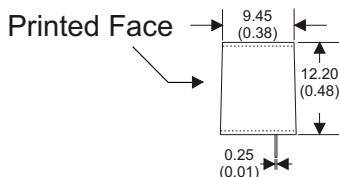

6 Pin SIL Package

- Notes : All dimensions are typical in millimeters (inches).
1. Pin diameter: 0.5±0.05 (0.02±0.002)
 2. Pin pitch and length tolerance: ±0.35 (±0.014)
 3. Pin to case tolerance: ±0.5 (±0.02)
 4. Case Tolerance: ±0.5 (±0.02)