

# VK-3W Series

3W 4:1 Regulated Single & Dual output

## Features

- Wide 4:1 Input Range
- 1500VDC Isolation, Up to 3500VDC
- Continuous Short Circuit Protection
- Efficiency up to 85%
- Operating Temperature Range -40 ~ 95°C max.



## PART NUMBER STRUCTURE

**VK** - **24** **05** **S** **3** **H**  
(1) (2) (3) (4) (5) (6)

### (1) Series

### (2) Input Voltage Range

**24** - 9-36 V  
**48** - 18-72 V

### (4) Output Type

**S** - Single Output  
**D** - Dual Output

### (3) Output Voltage

**3R3** - 3.3 V  
**05** - 5.0 V  
**7R2** - 7.2 V  
**09** - 9.0 V  
**12** - 12 V  
**15** - 15 V  
**18** - 18 V  
**24** - 24 V

### (5) Watt

### (6) Isolation Voltage

**Blank** - 1500 VDC  
**H** - 3500 VDC

ALL SPECIFICATIONS ARE TYPICAL AT 25°C, NOMINAL INPUT AND FULL LOAD UNLESS OTHERWISE NOTED

Model Number	Input Voltage Range (VDC)	Input Current		Output Voltage (VDC)	Output Current		Efficiency @FL (% , typ.)	Capacitive Load @FL (µF, max.)
		No-Load (mA, max.)	Full Load (mA, typ.)		Min. load (mA)	Full load (mA)		
VK-243R3S3	9-36	10	156	3.3	0	900	77	1000
VK-2405S3	9-36	15	157	5	0	600	80	1000
VK-247R2S3	9-36	15	157	7.2	0	416	80	100
VK-2409S3	9-36	15	153	9	0	333	82	330
VK-2412S3	9-36	15	149	12	0	250	84	220
VK-2415S3	9-36	15	151	15	0	200	83	47
VK-2418S3	9-36	15	151	18	0	166	83	10
VK-2424S3	9-36	18	155	24	0	125	81	10
VK-243R3D3	9-36	15	163	±3.3	0	±454	77	±470
VK-2405D3	9-36	15	157	±5	0	±300	80	±100
VK-247R2D3	9-36	20	155	±7.2	0	±208	81	±47
VK-2409D3	9-36	16	157	±9	0	±166	80	±47
VK-2412D3	9-36	18	157	±12	0	±125	80	±100
VK-2415D3	9-36	20	157	±15	0	±100	80	±22
VK-2418D3	9-36	25	157	±18	0	±83	80	±22
VK-2424D3	9-36	22	163	±24	0	±63	77	±22
VK-483R3S3	18-72	10	82	3.3	0	900	76	1000
VK-4805S3	18-72	12	79	5	0	600	80	680
VK-487R2S3	18-72	12	77	7.2	0	416	82	470
VK-4809S3	18-72	15	75	9	0	333	84	220
VK-4812S3	18-72	10	76	12	0	250	83	470
VK-4815S3	18-72	12	74	15	0	200	85	47
VK-4818S3	18-72	14	79	18	0	166	80	47
VK-4824S3	18-72	12	76	24	0	125	83	22
VK-483R3D3	18-72	10	80	±3.3	0	±454	79	±330
VK-4805D3	18-72	10	81	±5	0	±300	78	±220
VK-487R2D3	18-72	14	81	±7.2	0	±208	78	±47
VK-4809D3	18-72	15	79	±9	0	±166	80	±100
VK-4812D3	18-72	10	77	±12	0	±125	82	±220
VK-4815D3	18-72	15	80	±15	0	±100	79	±47
VK-4818D3	18-72	20	78	±18	0	±83	81	±22
VK-4824D3	18-72	15	79	±24	0	±63	80	±22

The information and specifications contained in this data sheet are believed to be correct at time of publication. However, **MOTIEN Technology** accepts no responsibility for consequences arising from printing errors or inaccuracies. Specifications are subject to change without notice. No rights under any patent accompany the sale of any such product(s) or information contained herein.

INPUT SPECIFICATIONS					
Parameter	Conditions	Min.	Typ.	Max.	Unit
Input Voltage Range	24V Input	9	24	36	VDC
	48V Input	18	48	72	
Input Filter		Pi Type			
Input Reflected Ripple Current (1)			35		mApk-pk
Start up Time	Nominal Vin and constant resistive load		500		ms
Recommended input fuse ( slow blow )	24V Input	0.63			A
	48V Input	0.315			
Note :					
1. Measured with a simulated source inductance of 12 $\mu$ H and a source capacitor Cin ( 47 $\mu$ F, ESR<1.0 $\Omega$ at 100kHz ).					

OUTPUT SPECIFICATIONS					
Parameter	Conditions	Min.	Typ.	Max.	Unit
Output Voltage Accuracy	3.3V Output	-2.0		+2.0	%
	Other Output	-1.0		+1.0	
Line Regulation		-0.5		+0.5	%
Load Regulation	From 0% to 100% Load	3.3V Output	-1.5	+1.5	%
		Other Output	-0.5	+0.5	
Cross Regulation	Asymmetrical Load 25% / 100% for Dual Output	-5		+5	%
Ripple & Noise (1)	20MHz bandwidth	24V Output		150	mVpk-pk
		Other Output		60	
Short Circuit Protection		Indefinite ( Automatic Recovery )			
Temperature Coefficient		-0.02		+0.02	%/ $^{\circ}$ C
Maximum Capacitive Load	Nominal Vin and constant resistive load	See Table			
Note :					
1. Measured with a 1.0 $\mu$ F MLCC.					

ABSOLUTE MAXIMUM RATINGS					
Parameter	Conditions	Min.	Typ.	Max.	Unit
Input Surge Voltage ( 100 ms )	24V Input			40	VDC
	48V Input			80	
Soldering Temperature	1.5mm from case 10sec max.			260	$^{\circ}$ C
Note : These are stress ratings. Exposure of devices to any of these conditions may adversely affect long-term reliability.					

GENERAL SPECIFICATIONS					
Parameter	Conditions	Min.	Typ.	Max.	Unit
Isolation Voltage	Input-output, and rated for 60sec	Standard Type	1500		VDC
		Suffix "H"	3500		
	Case-I/O, and rated for 60sec	1000			
Isolation Resistance	Input-output	1000			M $\Omega$
Isolation Capacitance	Input-output		500		pF
Switching Frequency			266		kHz
MTBF	MIL-HDBK-217 F @ 25 $^{\circ}$ C	1121			k hours
Safety Approval	IEC / EN / UL 62368-1	Designed to meet			
Environmental compliance		RoHS			

The information and specifications contained in this data sheet are believed to be correct at time of publication. However, **MOTIEN Technology** accepts no responsibility for consequences arising from printing errors or inaccuracies. Specifications are subject to change without notice. No rights under any patent accompany the sale of any such product(s) or information contained herein.

ENVIRONMENT SPECIFICATIONS					
Parameter	Conditions	Min.	Typ.	Max.	Unit
Operating Ambient Temperature	See the Derating Curve	-40		95	°C
Maximum Case Temperature				100	°C
Thermal Impedance		25			°C/W
Storage Humidity				95	% rel. H
Storage Temperature		-55		125	°C
Cooling	Natural Convection	30-65 LFM			

EMC SPECIFICATIONS			
Parameter	Standard	Condition	Criterion
Conducted Emissions	EN55032	with external components	A
Radiated Emissions	EN55032		A
ESD	IEC 61000-4-2	Air: ±8kV / Indirect: ±6kV	A
RS	IEC 61000-4-3	10V/m	A
EFT	IEC 61000-4-4	±2kV	A
Surge	IEC 61000-4-5	±1kV with external components	A
CS	IEC 61000-4-6	10Vrms	A
PFMF	IEC 61000-4-8	1A/m	A

PHYSICAL SPECIFICATIONS	
Parameter	Value
Case Material	Aluminum
Pin Material	Ø0.5mm Brass Solder-coated
Potting Material	Epoxy ( UL94V-0 rated )
Weight	13.0 g, typ.
Dimensions	1.25" x 0.8" x 0.4"

The information and specifications contained in this data sheet are believed to be correct at time of publication. However, **MOTIEN Technology** accepts no responsibility for consequences arising from printing errors or inaccuracies. Specifications are subject to change without notice. No rights under any patent accompany the sale of any such product(s) or information contained herein.

**ELECTRICAL CHARACTERISTIC CURVES**

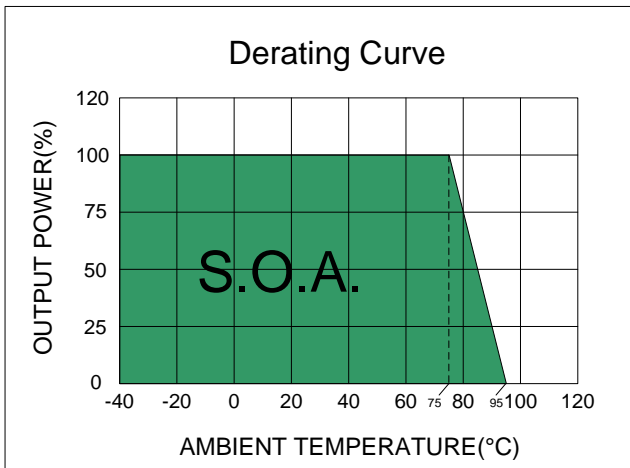

Efficiency 76% ~ 79% Models

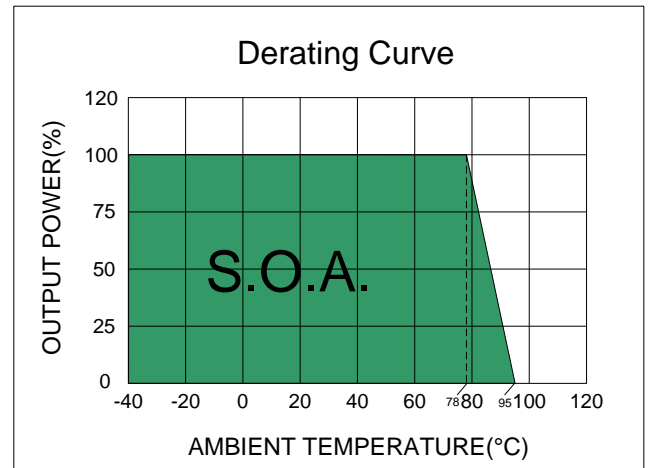

Efficiency 80% ~ 82% Models

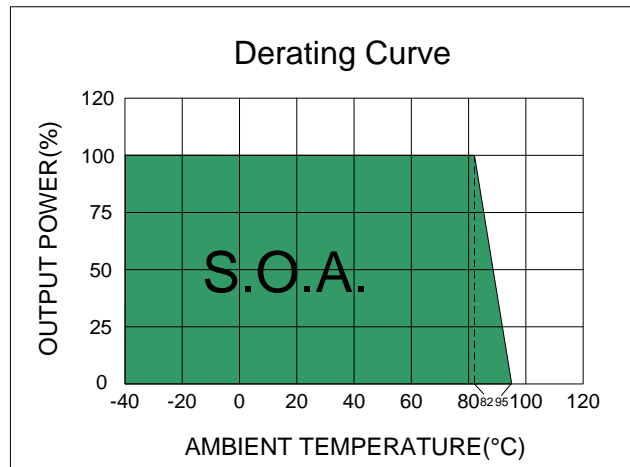

Efficiency 83% ~ 85% Models

**TEST CONFIGURATIONS**

**Input Reflected Ripple Current Test Step**

Input reflected ripple current is measured with a source inductor  $L_{in}$  ( 12 $\mu$ H ) and a source capacitor  $C_{in}$  ( 47 $\mu$ F, ESR<1.0 $\Omega$  at 100kHz ) at nominal input and full load.

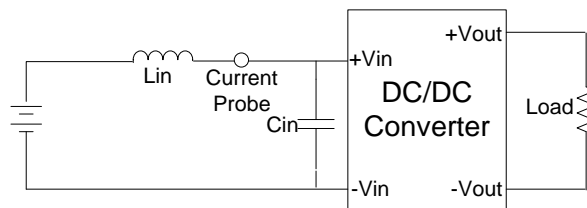

**DESIGN & FEATURE CONFIGURATIONS**

**EMC Filter**

The part (1) Circuit is used to meet Surge & EFT test, and the part (2) Circuit is used to meet EMI test.

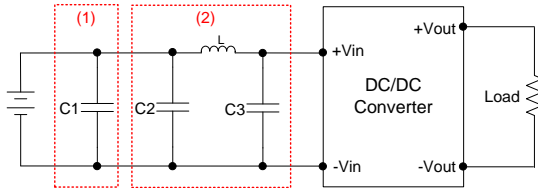

	C1	C2	L	C3
VK-24XXX3	NIPPON Chemi-con KY series 220μF, 100V	Nichicon PW series 68μF, 100V	12μH	Nichicon PW series 33μF, 100V
VK-48XXX3				

**MECHANICAL SPECIFICATIONS**

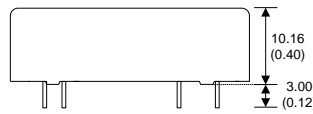
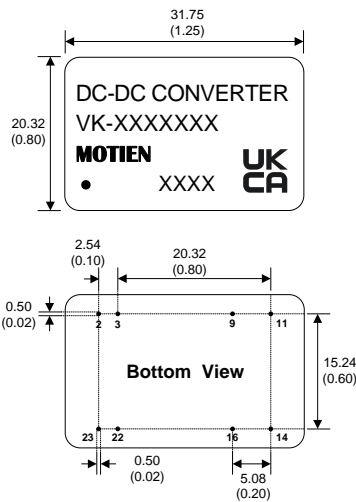

- Notes : All dimensions are typical in millimeters ( inches ).
1. Pin diameter: 0.5±0.05 ( 0.02±0.002 )
  2. Pin pitch and length tolerance: ±0.35 ( ±0.014 )
  3. Case Tolerance: ±0.5 ( ±0.02 )
  4. Stand-off tolerance: ±0.1 ( ±0.004 )

**PIN CONNECTIONS**

PIN NUMBER	SINGLE	DUAL
2	-Vin	-Vin
3	-Vin	-Vin
9	N.P.	COM
11	N.C.	-Vout
14	+Vout	+Vout
16	-Vout	COM
22	+Vin	+Vin
23	+Vin	+Vin

\*N.P. : No PIN  
\*N.C. : No Connection

**RECOMMENDED FOOTPRINT DETAILS**

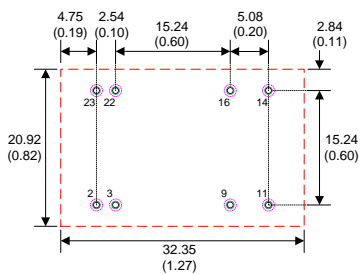

- Notes : 1. All dimensions are typical in millimeters ( inches ).
- Through hole ( black ) 2 ~ 23: Ø0.80 ( 0.031 )
  - Top view pad ( green ) 2 ~ 23: Ø1.00 ( 0.039 )
  - Bottom view pad ( pink ) 2 ~ 23: Ø1.60 ( 0.063 )