

VTW Series

Features 30W 4:1 Regulated Single & Dual & Triple output

- Ultra Wide 4:1 Input Range
- Full SMD Technology
- 1600 VDC Isolation
- Efficiency up to 91%
- Extended Operating Temperature Range -40 ~ 75°C max.
- Adjustable Output Voltage
- Remote On/Off Control (CTRL)
- Continuous Short Circuit Protection
- Over Current Protection
- Over Voltage Protection
- Over Temperature Protection
- Soft Start
- Optional Heat-sink

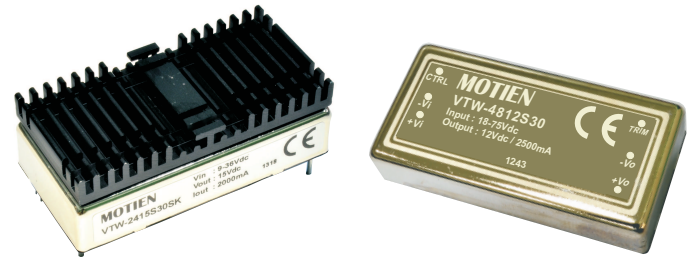

The VTW series is a family of cost effective 30W single & dual & Triple output DC-DC converters. These converters combine nickel-coated copper package in a 2"x1" case with high performance features such as Active Clamp Technology, continuous short circuit protection with automatic restart and tight line / load regulation. Devices are encapsulated using flame retardant resin. Input voltages of 24 and 48 with output voltage of 3.3 , 5 , 5.1, 12, 15, ±5, ±12, ±15Vdc, 3.3/±12, 3.3/±15, 5/±12, 5/±15 . High performance features include high efficiency operation up to 91% .

ALL SPECIFICATIONS ARE TYPICAL AT 25°C, NOMINAL INPUT AND FULL LOAD UNLESS OTHERWISE NOTED.

OUTPUT SPECIFICATIONS			GENERAL SPECIFICATIONS		
Output Voltage Accuracy	Single&Dual: ±1% Triple: ±1% / ±5% (main / auxiliary)		Efficiency	See table, typ.	
Output Voltage Adjustability (Single Output Only)	±10%, max.		I/O Isolation Voltage (60sec)	1600Vdc	
Maximum Output Current	See table		Input/Output	1600Vdc	
Line Regulation	Single&Dual: ±0.5%, max. Triple: ±1% / ±5% (main / auxiliary), max.		Case/Input & Output	1600Vdc	
Load Regulation	Single (0% to 100%): ±0.5%, max. Dual (0% to 100%): ±1%, max.(balanced load) Triple (10% to 100%): ±1% / ±5% (main / auxiliary), max.		Isolation Resistance	1000 MΩ, min.	
Cross Regulation (1)	Dual: ±5% Triple: ±5%		Isolation Capacitance	1000 pF, typ.	
Ripple&Noise (2)	Single&Dual : 100mVp-p,max. Triple : 50 / 75mVp-p, max. (main / auxiliary)		Switching frequency	330kHz, typ.	
Over Voltage Protection (Zener diode clamp)	3.3V output	3.9V	Humidity	95% rel H	
	5V output	6.2V	Reliability Calculated MTBF (MIL-HDBK-217 F)	Single&Dual: >435 khrs Triple: >320 khrs	
	5.1V output	6.2V	Safety Standard (designed to meet)	IEC/EN 60950-1	
	12V output	15V	EMC CHARACTERISTICS		
	15V output	18V	Radiated Emissions	EN55032	CLASS A
	±5V output	±6.2V	Conducted Emissions(7)	En55032	CLASS A
	±12V output	±15V	ESD	EN61000-4-2	Perf. Criteria A
±15V output	±18V	RS	EN61000-4-3	Perf. Criteria A	
Over Load Protection	150% of FL, typ.		EFT(8)	EN61000-4-4	Perf. Criteria A
Short Circuit Protection	Indefinite(hiccup) (Automatic Recovery)		Surge (8)	EN61000-4-5	Perf. Criteria A
Temperature Coefficient	±0.02%/°C		CS	EN61000-4-6	Perf. Criteria A
Capacitive Load (3)	See table		PFMF	EN61000-4-8	Perf. Criteria A
Transient Recovery Time (4)	250us, typ.		PHYSICAL SPECIFICATIONS		
Transient Response Deviation (4)	±3%, max.		Case Material	Nickel-coated Copper	
INPUT SPECIFICATIONS			Base Material	Non-conductive Black Plastic(UL94V-0 rated)	
Input Voltage Range	See table		Pin Material	Φ1.0mm Brass Solder-coated	
Under Voltage Lockout			Potting Material	Epoxy (UL94V-0 rated)	
24V Modes Module ON / OFF	8.6Vdc / 7.9Vdc, typ.		Weight	46.3g	
48V Modes Module ON / OFF	17.8Vdc / 16Vdc, typ.		Dimensions	2.00"x1.00"x0.40"	
Start up Time (Nominal Vin and constant resistive load)	30mS, typ.		ABSOLUTE SPECIFICATIONS (9)		
Input Filter	Pi Type		These are stress ratings. Exposure of devices to any of these conditions may adversely affect long-term reliability.		
Input Current (No-Load)	See table, max.		Input Surge Voltage(100mS)		
Input Current (Full-Load)	See table, typ.		24 Models	50 Vdc, max.	
Input Reflected Ripple Current (5)	20mA _{p-p} , typ.		48 Models	100 Vdc, max.	
Remote On/Off (CTRL)(6)			Soldering Temperature (1.5mm from case 10sec max.)	260°C, max.	
ON: 3.0 ... 12Vdc or open circuit			ENVIRONMENTAL SPECIFICATIONS		
OFF: 0 ... 1.2Vdc or Short circuit pin2 and pin 3			Operating Ambient Temperature	-40°C ~ +75°C(See Derating Curve) -40°C ~ +50°C(For 100% load)	
OFF idle current: 5 mA, typ.			Maximum Case Temperature	105°C	
			Thermal Impedance (Nature Convection)	Without Heat-sink 12°C/W With Heat-sink 10°C/W	
			Storage Temperature	-55°C ~ +125°C	
			Over Temperature Protection (Case)	115°C, typ.	
			Cooling(10)	Nature Convection	

The information and specifications contained in this data sheet are believed to be correct at time of publication. However, MOTIEN Technologies accepts no responsibility for consequences arising from printing errors or inaccuracies. Specifications are subject to change without notice. No rights under any patent accompany the sale of any such product(s) or information contained herein.

VTW - 30W 4:1 Regulated Single & Dual & Triple output

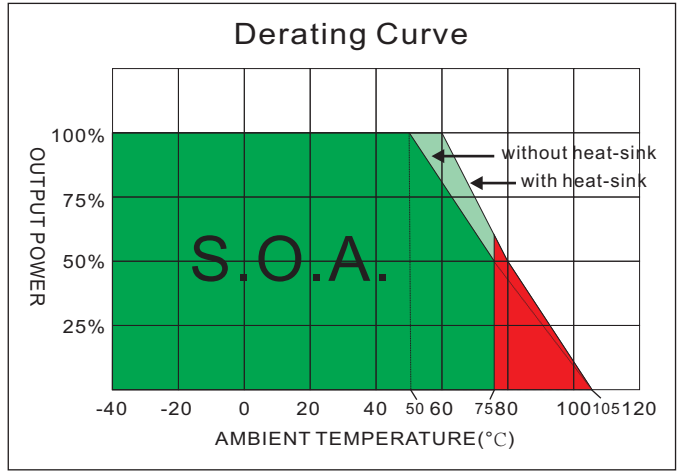
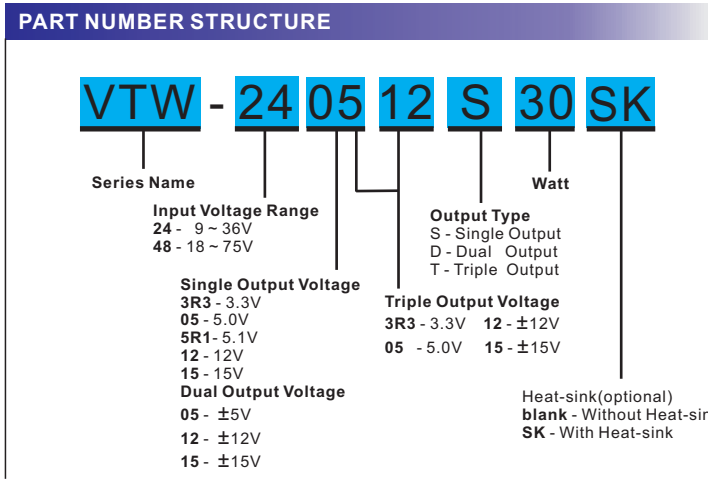

MODEL SELECTION GUIDE

MODEL NUMBER	INPUT Voltage Range (Vdc)	INPUT Current		OUTPUT Voltage (Vdc)	OUTPUT Auxiliary (Vdc)	OUTPUT Current		EFFICIENCY @FL (% , typ.)	Capacitor Load @FL (µF, max.)
		No-Load (mA, max.)	Full Load (mA, typ.)			Min. load (mA)	Full load (mA)		
VTW-243R3S30	9-36	100	1199	3.3		0	7500	89	20000
VTW-2405S30	9-36	100	1437	5		0	6000	90	14000
VTW-245R1S30	9-36	100	1465	5.1		0	6000	90	14000
VTW-24 12S30	9-36	50	1453	12		0	2500	89	2000
VTW-24 15S30	9-36	50	1453	15		0	2000	89	2000
VTW-483R3S30	18-75	100	599	3.3		0	7500	89	20000
VTW-4805S30	18-75	100	718	5		0	6000	90	14000
VTW-485R1S30	18-75	100	732	5.1		0	6000	90	14000
VTW-48 12S30	18-75	50	718	12		0	2500	90	2000
VTW-48 15S30	18-75	50	710	15		0	2000	91	2000
VTW-2405D30	9-36	100	1453	±5		0	±3000	89	±3000
VTW-24 12D30	9-36	50	1453	±12		0	±1250	89	±1300
VTW-24 15D30	9-36	50	1453	±15		0	±1000	89	±1300
VTW-4805D30	18-75	100	718	±5		0	±3000	90	±3000
VTW-48 12D30	18-75	50	727	±12		0	±1250	89	±1300
VTW-48 15D30	18-75	50	727	±15		0	±1000	89	±1300
VTW-243R312T30	9-36	100	1303	3.3	±12	500 / ±42	5000 / ±420	88	15000 / ±220
VTW-243R315T30	9-36	100	1294	3.3	±15	500 / ±33	5000 / ±330	88	15000 / ±220
VTW-240512T30	9-36	100	1457	5	±12	400 / ±42	4000 / ±420	89	8000 / ±220
VTW-240515T30	9-36	100	1448	5	±15	400 / ±33	4000 / ±330	89	8000 / ±220
VTW-483R312T30	18-75	50	644	3.3	±12	500 / ±42	5000 / ±420	89	15000 / ±220
VTW-483R315T30	18-75	50	647	3.3	±15	500 / ±33	5000 / ±330	88	15000 / ±220
VTW-480512T30	18-75	50	720	5	±12	400 / ±42	4000 / ±420	90	8000 / ±220
VTW-480515T30	18-75	50	715	5	±15	400 / ±33	4000 / ±330	90	8000 / ±220

NOTE

- Dual: One load is 25% to 100% load, the other load is 100% load, the output voltage variable rate is within ±5%.
Triple: Main output 100% load, auxiliary 100%, other auxiliary 25% to 100%.
Auxiliary outputs (+ Aux and - Aux) : main output 100% load, auxiliary 100%, other auxiliary 25% to 100% or main output 25%, auxiliary 25%, other auxiliary 25% to 100%.
- Measured with 20MHz bandwidth and 1.0uF ceramic capacitor.
- Tested by minimal Vin and constant resistive load.
- Tested by normal Vin and 25% load step change (75%-50%-25% of Io).
- Measured Input reflected ripple current with a simulated source inductance of 4.7uH.
- The remote on/off control pin is referenced to -Vin(pin2).
- The VTW series can meet EN55022 Class A With an external filter in parallel with the input pins .
- An external filter capacitor is required if the module has to meet EN61000-4-4 and EN61000-4-5.
The filter capacitor Motien suggest: Nippon chemi-con KY series, 220uF/100V.
- Exceeding the absolute ratings of the unit could cause damage.
It is not allowed for continuous operating.
- "Nature Convection" is usually about 30-65 LFM but is not equal to still air (0 LFM).

The models listed above is just for standard type. If you need the special specification product, please contact our service member by telephone presented in shortform cover or e-mail to : sales@motien.com.tw

Triple Series - TEST CONFIGURATIONS

Input Reflected Ripple Current Test Step

Input reflected ripple current is measured through a source inductor L_{in} (4.7uH) and a source capacitor C_{in} (33uF, ESR<1.0Ω at 100KHz) at nominal input and full load.

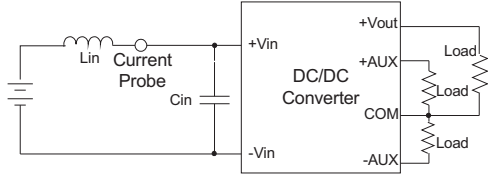

Output Ripple & Noise Measurement Test

Use a capacitor C_{out} (1.0uF) measurement. The Scope measurement bandwidth is 0-20MHz.

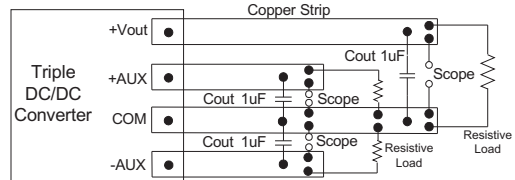

EMI Filter

Input filter components (C1, C3, L) are used to help meet conducted emissions requirement for the module. These components should be mounted as close as possible to the module; and all leads should be minimized to decrease radiated noise.

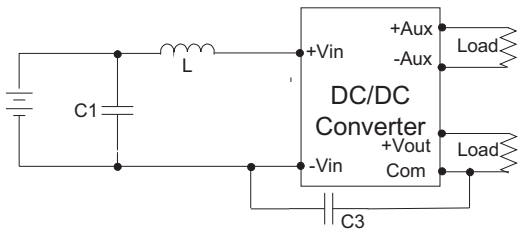

	C1	L	C3
VTW-24XXXXXXXXXX	100uF, 100V	12uH	1206,470PF, 2KV
VTW-48XXXXXXXXXX	100uF, 100V	12uH	1206,470PF, 2KV

Single & Dual Series - TEST CONFIGURATIONS

Input Reflected Ripple Current Test Step

Input reflected ripple current is measured through a source inductor L_{in} (4.7uH) and a source capacitor C_{in} (33uF, ESR<1.0Ω at 100KHz) at nominal input and full load.

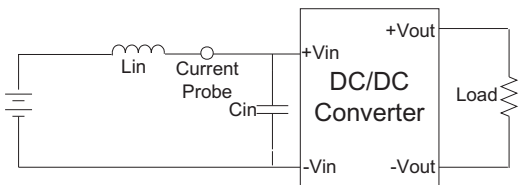

Output Ripple & Noise Measurement Test

Use a capacitor C_{out} (1.0uF) measurement. The Scope measurement bandwidth is 0-20MHz.

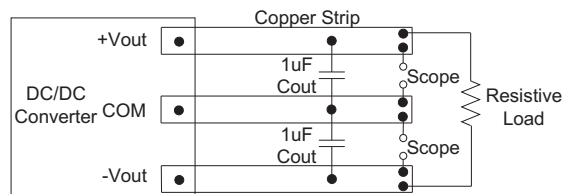

EMI Filter

Input filter components (C1, C3, L) are used to help meet conducted emissions requirement for the module. These components should be mounted as close as possible to the module; and all leads should be minimized to decrease radiated noise.

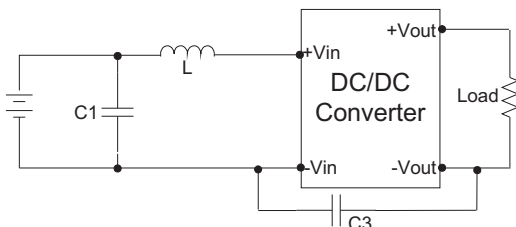

	C1	L	C3
VTW-24XXXXXXXXXX	100uF, 100V	12uH	1206,470PF, 2KV
VTW-48XXXXXXXXXX	100uF, 100V	12uH	1206,470PF, 2KV

VTW - 30W 4:1 Regulated Single & Dual & Triple output

ELECTRICAL CHARACTERISTIC CURVES

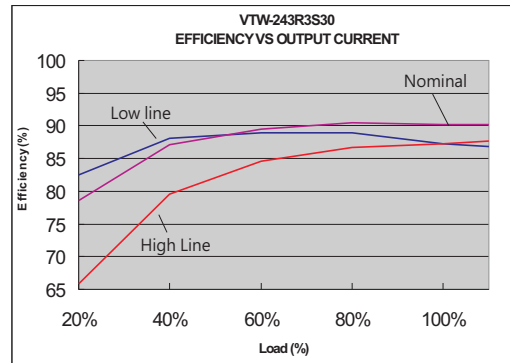
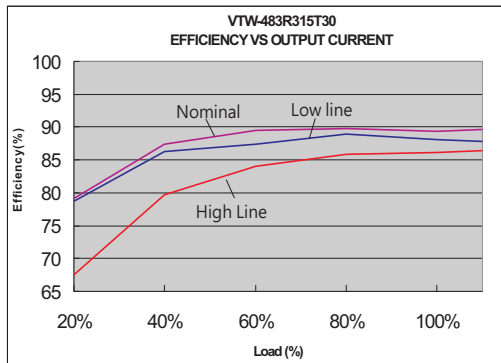
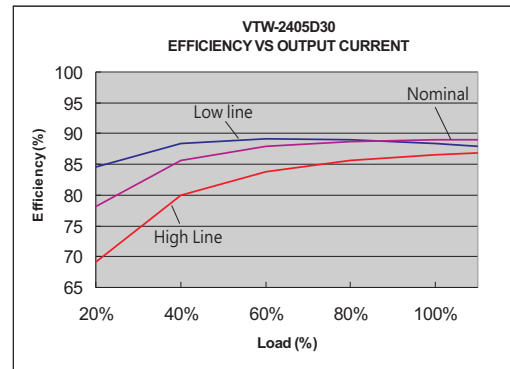
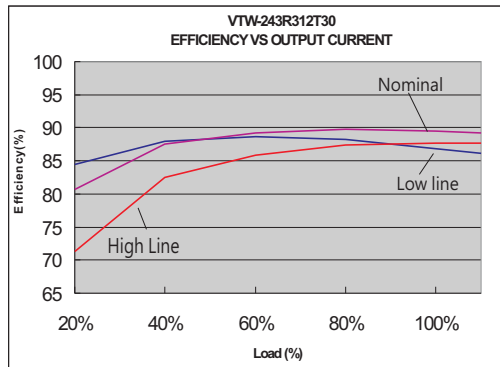

MECHANICAL SPECIFICATIONS

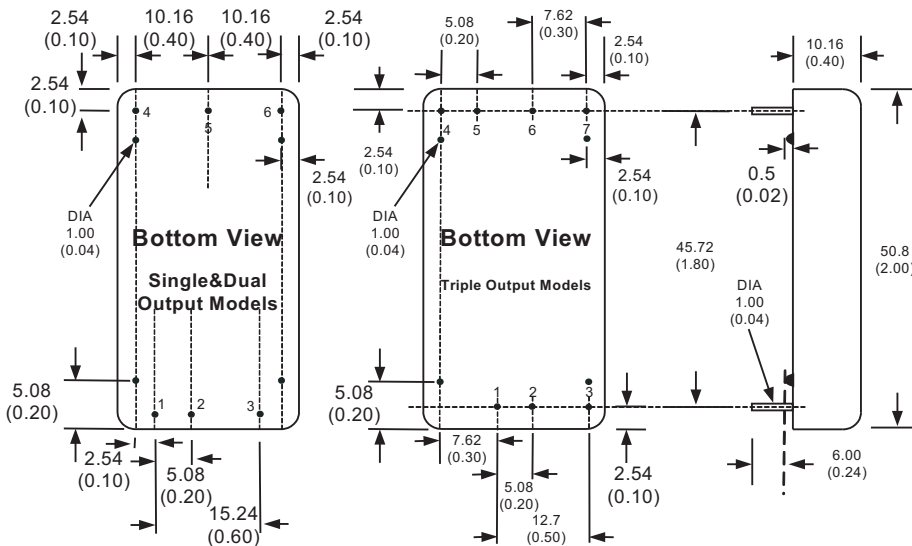

PIN CONNECTIONS			
PIN NUMBER	SINGLE	DUAL	Triple
1	+Vin	+Vin	+Vin
2	-Vin	-Vin	-Vin
3	CTRL	CTRL	CTRL
4	+Vout	+Vout	+Aux
5	-Vout	Com	-Aux
6	Trim	-Vout	Com
7	No pin	No pin	+Vout

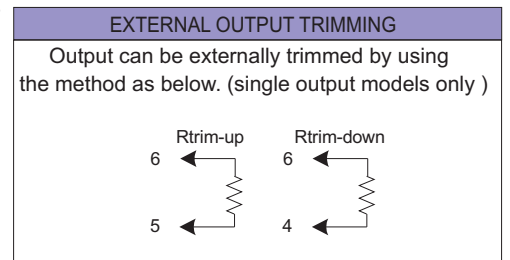

- All dimensions are typical in millimeters (inches).
1. Pin diameter: 1.0 ± 0.05 (0.04 ± 0.002)
 2. Pin pitch and length tolerance: ± 0.35 (± 0.014)
 3. Case Tolerance: ± 0.5 (± 0.02)
 4. Stand-off tolerance: ± 0.1 (± 0.004)

MECHANICAL SPECIFICATIONS

With Heat-sink

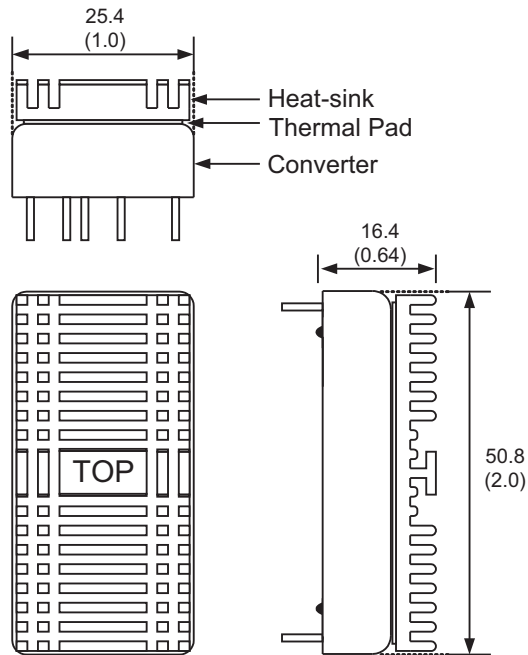

Order code: VT-XXXXS30SK(contain: heat-sink, thermal pad)
 Material: Aluminum
 Finish: Anodic treatment (black)
 Weight: 11.2 g (0.39oz) (without converter)

Note:

1. Converters will be supplied with heat-sinks already mounted.
Please contact factory for quotation.